

1  
2  
3  
4  
5  
6  
7  
8  
9  
10  
11  
12  
13  
14  
15  
16  
17  
18  
19  
20  
21  
22  
23  
24  
25  
26  
27  
28

RESOLUTION NO. 3013

A RESOLUTION OF THE CITY COUNCIL OF THE CITY OF KELLER, TEXAS, APPROVING AN AMENDED SITE PLAN FOR CAPITAL ONE BANK, A 8,049 SQUARE-FOOT BANK BUILDING, LOCATED ON A 1.37-ACRE LOT ON THE SOUTHEAST CORNER OF KELLER PARKWAY (FM 1709) AND SOUTH MAIN STREET (U.S. HIGHWAY 377), AT 100 KELLER PARKWAY, BEING LOT 1, BLOCK A, HIBERNIA-KELLER ADDITION, AND ZONED R-OTK (RETAIL-OLD TOWN KELLER OVERLAY), IN THE CITY OF KELLER, TARRANT COUNTY, TEXAS.

WHEREAS, Capital One Bank, owner and Levinson Alcoser Associates, LP., applicant, have submitted a site plan (SP-10-0010), which has been reviewed by the City Staff and recommended for approval with conditions by the Planning and Zoning Commission of the City of Keller.

NOW, THEREFORE, BE IT RESOLVED BY THE CITY COUNCIL OF THE CITY OF KELLER, TEXAS:

Section 1: THAT, the above findings are hereby found to be true and correct and are incorporated herein in their entirety.

Section 2: THAT, the amended site plan for Capital One Bank, a 8,049 square-foot bank building, located on a 1.37-acre lot on the southeast corner of Keller Parkway (FM 1709) and South Main Street (U.S. Highway 377), at 100 Keller Parkway, being Lot 1, Block A, Hibernia-Keller Addition, and zoned R-OTK (Retail-Old Town Keller Overlay) is hereby approved, attached hereto with Exhibit "A" as amended by Exhibit "B", and incorporated herein as if fully set forth with the following conditions:

1. The variance request to reduce the amount of ornamental trees within the north landscape buffer from eleven (11) ornamental to five (5) ornamental trees shall be allowed.

1  
2  
3  
4  
5  
6  
7  
8  
9  
10  
11  
12  
13  
14  
15  
16  
17  
18  
19  
20  
21  
22  
23  
24  
25  
26  
27  
28

2. The variance request to reduce the amount of ornamental trees within the west landscape buffer from seven (7) ornamental trees to four (4) ornamental trees shall be allowed.
3. The variance request to waive the required trees to be added in barren areas within the west landscape buffer shall be allowed.
4. The variance request to waive the required trees within one (1) landscape parking island on the east side of the drive-thru banking lanes shall be allowed.
5. The variance request to waive the required foundation plantings on the north, west, and east sides of the building shall be allowed.
6. All requirements and conditions of Resolution No. 2220, approving the site plan for Hibernia National Bank, shall continue to be applicable.

1  
2  
3  
4  
5  
6  
7  
8  
9  
10  
11  
12  
13  
14  
15  
16  
17  
18  
19  
20  
21  
22  
23  
24  
25  
26  
27  
28

AND IT IS SO RESOLVED.

Passed and approved by a vote of 3 to 2 on this the 16th day of November, 2010.

CITY OF KELLER, TEXAS

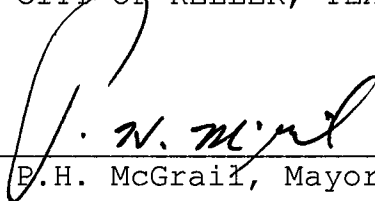
BY:   
P.H. McGrail, Mayor

ATTEST:

  
Sheila Stephens, City Secretary

Approved as to Form and Legality:

  
L. Stanton Lowry, City Attorney

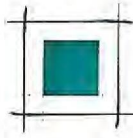

LEVINSON • ALCOSER  
A S S O C I A T E S , L P .

October 21, 2010

City of Keller  
Development Review Committee  
Planning and Zoning Commission  
City Council

RE: Variances to Unified Development Code for Capital One Bank at 100 Keller Parkway, Keller, TX 76248

To Whom It May Concern:

The variance being requested is for the Capital One Bank Building on the southwest corner of FM 1709 and 377. The building and drive thru paving are experiencing foundation distress due to heaving of the subgrade soils, some areas as much as 2 ½" within the building. A swell test was performed by a Geotechnical Engineer and provided results that indicated the building would experience an additional 1 ½" of swelling of the subgrade soils. It was recommended to isolate the active soils under and around the building and drive thru to prevent further migration of water into the subgrade soils.

This building foundation was constructed in June 2005 and the bank was completed in November 2005. Capital One has been in ownership of the building since April 2008. The building has had foundation issues prior to March 2008 when we were notified and asked to review the situation. We do not believe that there are any alternatives available to save the landscape surrounding this building that will accomplish the same recommendations to eliminate the foundation heave potential that we are trying to achieve with this construction. The site has been tested for leaks and other sources of water infiltration under the foundation; however no leaks were found. It was determined that source of the heaving soil was from water and groundwater infiltration through the exposed landscaping areas. The bank was constructed with grade beams and a slab on grade. We are currently investigating five other branches that are experiencing the same type of swelling and heaving. We are proposing to install similar hardscape at all the branches and groundwater walls at those branches that are experiencing groundwater migration. Capital One has since changed the prototype design criteria to require structural slabs in all their new branches to prevent this problem from occurring.

The following variances are being requested:

- 1) The variance request to Section 9.03 (F.2.b) of the Unified Development Code (UDC) to reduce the required amount of ornamental trees within the north landscape buffer from eleven (11) ornamental trees to five (5) ornamental trees.



LEVINSON • ALCOSER  
A S S O C I A T E S , L P

- 2) The variance request to Section 9.03 (F.2.b) of the Unified Development Code (UDC) to reduce the required amount of ornamental trees within the west landscape buffer from seven (7) ornamental trees to four (4) ornamental trees.
- 3) The variance request to Section 9.03 (F.2.d) of the Unified Development Code (UDC) to waive the requirement of new trees to be added to barren areas within the west landscape buffer.
- 4) The variance request to Section 9.03 (F.3.f) to waive the required landscaping within one (1) parking island to the east of the building adjacent to the drive-thru banking lanes.
- 5) The variance request to Section 9.03 (F.3.j) of the Unified Development Code (UDC) to waive the required five foot (5') foundation plantings along the north, east and west sides of the building.
- 6) All requirements and conditions of Resolution No. 2220, approving the Site Plan for Hibernia National Bank, shall continue to be applicable.

Justification for variance items 1-5 above: The existing bank building foundation is in distress and experiencing heave under the building and drive thru due to moisture compromising the subgrades. The plans submitted for approval include the installation an 8' deep Groundwater Cut-Off Trench that will surround the existing building and drive-thru. The removal of existing landscape and irrigation and the installation of hardscape in these areas are necessary to prevent future water from infiltrating the areas surrounding the building.

After reviewing the site, it has come to our attention that trees have been removed without the appropriate permits. Four (4) protected trees have been removed along with nine (9) required trees (four (4) required canopy trees and five (5) required ornamental trees). Capital One will install replacements for the seven (7) of the nine (9) removed required trees, omitting two (2) required ornamental trees along Keller Parkway that are proposed to be removed as part of the Site Plan Amendment application. In the event that the Site Plan Amendment is not approved as proposed, Capital One Bank will install replacements for the two (2) required ornamental trees that were removed from Keller Parkway. Capital One Bank is also making a request to the Tree Board to pay in lieu of mitigating the deficit of the 61.4 caliper inches (resulting from removal of four (4) protected trees) with replacement trees.

Sincerely,

Amanda Buckson, RLA, LEED AP  
Levinson Alcoser Assoc., LP.

**GEOTECHNICAL DISTRESS STUDY**

**CAPITAL ONE BANK**

**KELLER BRANCH**

**KELLER, TEXAS**

Reported to  
Capital One Bank  
Plano, Texas

Prepared by  
Kenneth E. Tand & Associates, Inc.  
Geotechnical & Materials Engineers  
Houston, Texas

Project No. 10-113

March, 2010

**KENNETH E. TAND & ASSOCIATES, INC.**  
**GEOTECHNICAL & MATERIALS ENGINEERS**

March 22, 2010

Capital One Bank  
5718 Westheimer Rd., Suite 1850  
Houston, Texas 77057  
Attn: Ms. Beth Tiderman

Ref: Geotechnical Distress Study  
Capital One Bank  
Keller Branch  
Keller, Texas

Dear Ms. Tiderman:

KETA has completed our geotechnical engineering studies directed at evaluating the cause of heave of the ground supported floor slab, and providing conceptual recommendations for remedial repairs. This report summarizes our findings and presents our conclusions.

**Introduction**

The branch bank is located on the southwest corner of SH 377 (N. Main) and FM 1709 (Keller Blvd.). The structure is a 1-story steel frame building with an attached drive thru teller. It was previously a Hibernia bank, and it was constructed in 2005.

The geotechnical investigation report for the bank was performed by HBC/Terracon (report 94045200) in November 2004. The architect-of-record was Oglesby Holtman, and the structural engineer-of-record was the Structural Studio. The foundation system (sheet S-3.2) is underreamed piers bearing at a depth of 18 feet below finished floor.

**Scope of Work**

The purpose of our geotechnical engineering studies was to render an opinion as to the probable cause of the distress, and to make conceptual recommendations for remedial repair. The scope of work included the following:

1. I made an initial site visit on 2/19/10 to observe the problems occurring in the building.
2. I reviewed the geotechnical investigation report prepared by HBC/Terracon to evaluate the subsoil conditions as to how they may have contributed to the building distress.
3. I reviewed the foundation plans prepared by the Structural Studio.
4. KETA's subcontractor, Cut-N-Shoot, cored thru the concrete slab at two locations. Our geotechnical staff then drilled two borings to depths of 15 feet using hand auger equipment. Somewhat undisturbed samples were taken on two foot centers by driving 3-inch Shelby tubes into the clays using a sledge hammer. The samples were left in the Shelby tubes for transport to our office. Disturbed samples from the auger cuttings were also obtained when drilling the borings. The boring logs and a boring location plan are enclosed in the Appendix.

**Ms. Beth Tiderman  
Capital One Bank**

5. KETA's laboratory staff performed Atterberg limit, suction, and swell tests to evaluate the swell potential. Pocket penetrometer tests were performed to evaluate the shear strength of the clay subsoils. The test results are summarized on the boring logs, and on the summary of swell and suction tests in the Appendix.
6. This report was prepared by Kenneth E. Tand, P.E. summarizing our findings, and making recommendations for remedial repair.

### Area Geology

The site is located on Grayson Marl/Main Street Limestone formation (Geology Atlas of Texas/Dallas Sheet). The upper soils are characteristic of the Grayson Marl. "The marl is yellowish-brown and locally contains pyrite seams and fossils, gypsum, and interspersed thin limestone bands..." (The Geology of Tarrant County – 1931).

### Subsoil Conditions

The subsurface stratigraphy is shown in detail on each of the boring logs. The stratigraphy can be generalized as follows:

<u>Depth –ft.</u>	<u>Description</u>	<u>Unified Classification</u>
0 - .5	Concrete floor slab	—
.5 – 1.5	Fill: Very stiff sandy clay (1)	CL
1.5 – 10	Fill: stiff clay/silty clay (2)	CH/CL
10 – 12	Very stiff to hard clay (3)	CH
12 – 15	Hard shaley clay (4)	CH

(1): The liquid limit ranged from 32 to 44 with an average of 37. The plasticity index ranged from 15 to 26 with an average of 21. **The sandy clay fill would be classified as having a medium shrink/swell potential (Chen 1988).**

(2): The liquid limit ranged from 45 to 51, with an average of 48. The plasticity index ranged from 27 to 31, with an average of 29. **The shrink/swell potential of the clay fill would be classified as high (Chen 1988).**

(3): The average liquid limit was 75, and the plasticity index was 44. **The shrink/swell potential of the clay subsoils would be classified as high (Chen 1988).**

(4): The average liquid limit is 54, and the plasticity index is 33. **The shrink/swell potential of the shaley clay is high (Chen 1988).**



HBC/Terracon (June 2004) did not encounter groundwater when drilling the 2 borings under the building. Also, KETA's geotechnical staff did not observe free water when drilling.

### **Differential Movement of the Floor Slab**

Jacobs/Carter Burgess (March, 2008) and Webb Surveying (October, 2009) performed elevation surveys on the ground supported floor slab. The floor slab is not level, and the measured differential movement is  $\pm 2\frac{1}{2}$  inches. Comparison of the two surveys suggests that  $\pm 1\frac{1}{2}$  inches of heave occurred between March 2008 and October 2009. Discussions with the maintenance personnel indicates that movements are still occurring.

The elevations only reflect relative movement between different spots on the floor. Our experience indicates that construction tolerances are commonly  $\pm \frac{1}{2}$  inch, but sometimes differences are as much as  $\pm 1$  inch (or more) if the contractor exercises poor elevation control.

The clays of the Grayson Marl formation are highly overconsolidated, but some short and long term settlement of the underreamed piers can be expected. It is my opinion that  $\pm \frac{1}{4}$  inch of load induced settlement of the piers could be expected.

It is not possible to determine how much settlement of the underreamed piers actually occurred, or how much heave of the expansive clays occurred because a deep benchmark had not been set at the time of construction to provide a reference between construction and post construction elevations. It is KETA's opinion that the probable heave is  $\pm 2$  inches.

Differential movement caused cracks in interior sheetrock walls and tile floors, unlevel floors, sticking doors, movement of ceiling tiles, and cracks in exterior walls. The doors have been adjusted, and cracks in the dry wall have been fixed as they occurred. Photos were taken in March 2008, and August 2009 documenting the on going problems.



Separation between door frame and dry wall



Sticking bathroom door

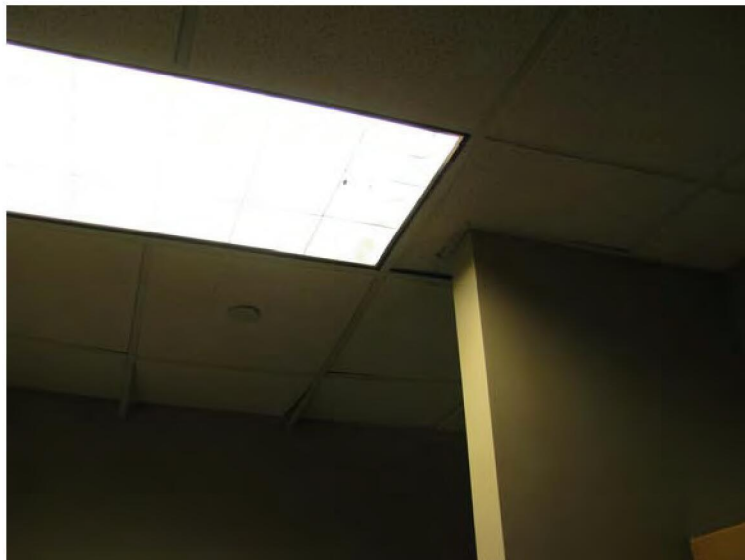

Movement of Ceiling Tiles

**Underreamed Piers**

HBC/Terracon specified a bearing depth of 18 feet (ref. 2004 datum) in their geotechnical investigation report. Reed Engineering's "Report of Pier Observation" indicated that the "as built" depth of the piers was  $17.5 \pm 3$  feet. The piers were sized for an allowable bearing pressure of 5,000 pounds per square foot (psf). The footing depth and bearing pressure are consistent with local practice.

Ms. Beth Tideman  
Capital One Bank

### **Potential Vertical Rise (PVR)**

HBC/Terracon estimated that the PVR of the untreated clay subsoils was 2 to 3 inches. In their report, they discussed that structural suspension of the floor slab was the “only method of assuring the absence” of vertical movements distressing the foundation and floor slab. Furthermore, they discussed support of the floor slab on 8 feet of reworked (moisture conditioned) fill as an alternate solution if some slab movements were tolerable (PVR ~ 1 inch). They recommended placement of a minimum of 12 inches of select fill (PI between 6 and 15), or 6 inches of lime stabilized clay above the moisture conditioned fill to minimize moisture losses during construction.

KETA used the subsoil data in HBC/Terracon’s borings (minimal number of Atterberg limit tests had been performed), and computed a PVR (Tex 124-E) of 2 inches for swell from dry conditions. An active depth of 15 feet depth was assumed, but this depth could be greater if long term saturation of the clays occur. This value is within the PVR values reported by HBC/Terracon.

KETA computed a PVR (Tex 124-E) of  $\frac{3}{4}$  inch assuming swell from optimum condition for the 10 feet of fill, and dry condition of the expansive clays to 15 feet. A surcharge pressure of 1 psi was added to consider the confining pressure of the slab resulting from diaphragm action.

The  $\pm 2$  inches of measured swell has exceeded HBC/Terracon’s predicted swell of 1 inch, and the Tex 124-E prediction of  $\frac{3}{4}$  inch. Plausible explanations are that the swell potential was not adequately reduced when reworking the clays at a moisture content of +4 percentage points above the optimum moisture (ASTM D 698), the upper portion of the clay fill dried out during construction, or that an appreciable amount of heave of the clays below the moisture conditioned fill occurred.

KETA computes that the potential heave is presently  $\pm 1\frac{1}{2}$  inches using results of the swell tests. These calculations assumed that the active depth is 15 feet below top of slab, and that the clays become 100 percent saturated. The probability of the clays becoming 100 percent saturated is low unless there is a long term plumbing leak, or standing water at the perimeter of the building. It is KETA’s opinion that the potential heave is presently  $\pm 1\frac{1}{4}$  inch, and the actual heave will depend upon the future moisture changes.

### **Moisture for Swelling**

There must be a source of moisture for swelling to occur. Some heave will generally occur do to a change in suction resulting from placing a floor slab at the surface, especially if the building is air conditioned. However, it is our experience that the magnitude of heave will generally be small.

The wetting front is generally top/down in a barren field, and results from rain. However, the wetting front will change when a slab is placed on ground because the slab prevents

**Ms. Beth Tiderman**  
**Capital One Bank**

infiltration of water into the subsoils. The source of moisture to cause swelling below the floor slab is generally from rainfall or irrigation in landscape areas close to the slab, or from seepage thru cracks and joints in paving next to the slab.

However, the high moisture content of the clay fill could be due to leaks in underground utilities. This fact is unknown, and it must be studied further before remedial repairs can be made. Also, it is possible that the water source is infiltration of rainfall or irrigation water into landscape areas close to the building and then horizontal seepage under the floor slab thru utility trench backfill or void spaces below grade beams.

### **Moisture Conditioned Fill Pad**

It is common practice in the greater Dallas/Fort Worth metroplex to support floor slabs on moisture conditioned clay fill to minimize foundation movements due to heave of the expansive clay subsoils. Review of Reed Engineering's "Report of Field Density Tests" indicates that the fill met HBC/Terracon's recommendations within accepted industry tolerances. However, I question whether the +4 percent moisture criteria was adequate to reduce the PVR to 1 inch or less.

### **Trench Backfill and Clay Plugs**

It is KETA's experience that water can backflow from exterior planter beds to interior portions of the slab if sand had been used as backfill in the trenches. Also, a leak in an interior utility line would allow water to flow along a sand filled trench causing heave of the floor slab to occur in areas well beyond the leak. HBC/Terracon recommended use of clay backfill to seal the underground utilities from migration of water, and use of a "cut off" at the perimeter of the building to seal out exterior water. No field exploration has been performed to determine whether HBC/Terracon's recommendations had been implemented.

### **Remedial Repairs**

**The first step is to locate the source of water causing heaving of the expansive clays.** KETA recommends that a leak detection company be employed to check the underground utilities for leaks. This would include inspecting the underground utility lines using a camera, and performing leak detection tests as required. Also, the ends of the utility lines where they exist the building should be checked for the presence of sand backfill. If present, a bentonite clay plug should be placed at the end so that water can not flow from outside of the building back under the floor slab through the permeable backfill. This includes the exterior cleanouts since they slope back under the building.

The most positive procedure to minimize the effects of future movements is to remove the ground supported floor slab, and replace it with a structural slab cast with a minimum 6 inch void space below the slab. This would require installation of additional underreamed piers or auger cast-in-place piles (ACIP) under the new floor slab. However, the heave was less than 1½ inches

**Ms. Beth Tiderman  
Capital One Bank**

in most areas of the building and the building is serviceable. This method of remedial repair would be disruptive, not to mention very costly.

The most practical method of repair is to control moisture considering the high cost of a structural slab, and the disruption that would occur. As discussed above, all leaks in underground utilities should be repaired, if any exist, and a moisture barrier should be installed around the three unpaved sides of the building. A vertical moisture barrier next to the building penetrating 8 feet below grade is the most positive system. However, this would require removing the sidewalks and would be disruptive.

A horizontal moisture barrier would not be as effective as a vertical barrier, but would be less disruptive and less costly. Conceptually, the horizontal barrier should consist of removing the landscaping and concreting the area. An option (not equal) is placement of a plastic liner such as Stego Wrap buried 2 ½ feet deep below the top of the landscape beds, and the existing sidewalks and paving will seal the remaining surface. The liner should penetrate below the sidewalks, and it should be glued to the grade beams. An underdrain can be installed on top of the liner away from the building to collect water in the landscape beds to minimize root rot.

### **Summary**

Webb's October 2009 elevation survey suggests that  $\pm 2\frac{1}{2}$  inches of heave of the clay subsoils has occurred. About 1½ inches of heave occurred between March 2008 and October 2009. Discussions with the maintenance personnel indicates that movement is still occurring. It is KETA's opinion that most of the initial heave was due to swelling of the clay fill, but I suspect that swelling of the deeper clays is presently occurring.

Results of KETA's swell tests indicate that  $\pm 1\frac{1}{2}$  inches of additional heave could occur. However, this would require 100 percent saturation to 15 feet, and it is KETA's opinion that  $\pm 1$  inch is a more plausible expectation.

Changes in the moisture content of the clay subsoils is required for swelling to occur. Thus, the most plausible method to minimize additional heave is to control moisture variations with use of a vertical or horizontal moisture barrier.

### **Limitations**

The two soil borings drilled by KETA for this study actually present an extremely small area of the site. Somewhat differing subsoil conditions should be expected across the site due to the heterogeneous nature of the subsoil deposits typical of the Grayson Marl/Main Street Limestone formation. Such unknowns are typical for this type of study, and there are also unknowns regarding the "as built" foundations.

The scope of this report did not include a detailed forensic study. KETA was not provided a complete set of the plans and specifications, RFI's and other documents submitted during construction, or all of the testing reports prepared during construction. KETA did not perform

**Ms. Beth Tiderman**

**Capital One Bank**

standard Proctor density tests on the fill, nor did we mold samples to test the swell potential at the specified moisture criteria. Also, KETA did not check the utility lines for the presence of sand backfill, or for a “cut off” barrier at the perimeter. Additional studies will be required if this matter proceeds to litigation.

The options for remedial repair discussed in this report are conceptual in nature. A set of detailed plans and specifications prepared by an architect and structural engineer will be required prior to start of construction. KETA performed this geotechnical engineering study with the skill and care commonly practiced by other registered geotechnical engineers practicing in the State of Texas at the time this study was performed. There is no warranty, either expressed or implied, other than performing our work to these standards.

**Closure**

We appreciate the opportunity of working with you on this phase of the project. If you have any questions regarding this report, please call on us.



Sincerely,



Kenneth E. Tand, P.E.  
Texas Firm No.: F-2977

KET/sbs

X:\10-113 Keller Branch (Capital One)\Geotech\10113\_03.doc

cc: Levinson Alcoser (Mark Fieglein)

***APPENDIX***

Boring Location Plan

Log of Borings

Key Symbol Sheet

Summary of Swell & Suction Tests

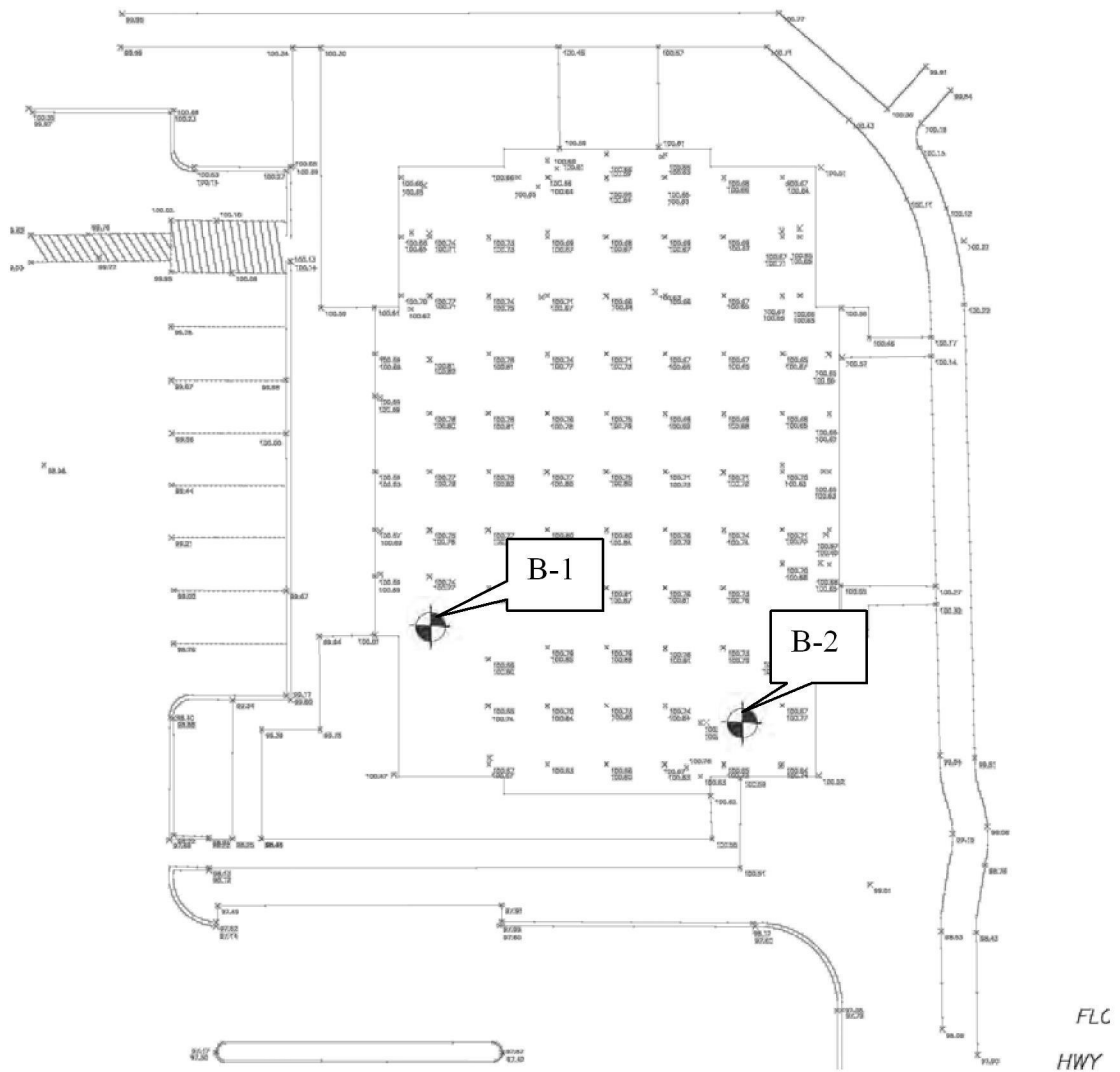

**Boring Location Plan**  
 Keller Branch Bank  
 Keller, Texas  
 KETA No.: 10-113





















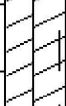









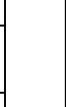

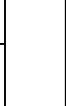
**LOG OF BORING NO. B-1**

Project Name: Keller Branch Bank

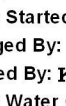
Location: Keller, Texas

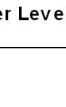
KETA No.: 10-113

Sheet 1 of 1

Depth, feet	Graphic Log	Material Description	Samples	SPT Test, Blows/ft.	Pocket Pen, tsf	Compression, tsf	Type Failure	Strain, %	Moisture, %	Dry Density, pcf	Liquid Limit, %	Plasticity Index, %	% Passing #200
		5.8" concrete slab											
		Fill: Very stiff brown sandy clay, with roots & gravel							15		32	15	
		Fill: very stiff dark gray clay/silty clay -color change to tan & gray at 2', with gravels & plastic -stiff below 3'			2.5				17		44	26	
					2.2				18				
									23		51	31	
									17				
5		-color change to dark gray & gray at 5', with roots			1.2				21		45	27	
		-color change to tan & gray at 6', with calcareous nodules			1.4				20				
									21		48	27	
									23				
					1.4				17		49	31	
									24				
		Very stiff to hard tan & light gray clay (weathered marl), blocky			4.5+				21		77	44	
									22				
		Hard tan & light gray shaley clay (weathered marl), blocky							19				
					4.5+				16		53	31	
15		Refusal to hand auger equipment at 15 ft.											
20													

Completion Depth (ft.): 15 ft.  
 Date Started: 2/21/10  
 Logged By: LB  
 Edited By: KT  
 Free Water Observed During Drilling (ft.): None  
 Water Level (ft/hr.):































**LOG OF BORING NO. B-2**

Project Name: Keller Branch Bank

Location: Keller, Texas

KETA No.: 10-113









Sheet 1 of 1

Depth, feet	Graphic Log	Material Description	Samples	SPT Test, Blows/ft.	Pocket Pen, tsf	Compression, tsf	Type Failure	Strain, %	Moisture, %	Dry Density, pcf	Liquid Limit, %	Plasticity Index, %	% Passing #200
		5.1" concrete slab											
		Fill: stiff reddish brown & gray sandy clay, with gravels							20		36	22	
		Fill: very stiff tan, gray & dark gray clay/silty clay -color change to tan & light gray at 2'			2.7				16				
		-with fine roots at 4'			1.4				23				
									20				
5									21				
		-color change to tan & dark gray at 6', with fine roots -color change to tan & light gray at 7'			2.3				22				
									20				
					1.2				24				
									24				
10		Very stiff to hard tan & light gray clay (weathered marl), blocky			1.2				22		53	30	
									23				
		Hard tan & light gray shaley clay (weathered marl), blocky			3.0				28		75	44	
									24				
									22				
15		Refusal to hand auger equipment at 15 ft.			4.5+				23		55	35	
20													

Completion Depth (ft.): 15 ft.  
 Date Started: 2/21/10  
 Logged By: DT  
 Edited By: KT  
 Free Water Observed During Drilling (ft.): None  
 Water Level (ft/hr.):

## KEY TO SOIL CLASSIFICATION AND SYMBOLS

### SOIL TYPES

	Gravel (GW, GP, GM, GC)		Silt (ML)
	Sand (SW, SP)		Sandy Silt (ML)
	Silty Sand (SM)		Silty or Sandy Clay (CL)
	Clayey Sand (SC)		Clay (CH)

### CONSISTENCY OF COHESIVE SOILS

<u>Description</u>	<u>Shear Strength-KSF</u>
Very Soft	Less than 0.25
Soft	0.25 – 0.50
Medium Stiff	0.50 – 1.00
Stiff	1.00 – 2.00
Very Stiff	2.00 – 4.00
Hard	Greater than 4.00

### RELATIVE DENSITY OF COHESIONLESS SOIL

<u>Description</u>	<u>Relative Density-%</u>
Very Loose	0 – 15
Loose	15 – 35
Medium Dense	35 – 65
Dense	65 – 85
Very Dense	85 – 100

### SOIL STRUCTURE

CALCAREOUS NODULES	— Nodules of calcium carbonate
FERROUS NODULES	— Nodules of ferrous material
SLICKENSIDED	— Having planes of weakness that are slick and glossy
BLOCKY	— Having inclined planes of weakness that are frequent and rectangular in pattern
LAMINATED	— Composed of thin lenses of varying soil type and texture
FISSURED	— Containing shrinkage cracks frequently filled with fine sand
INTERBEDDED	— Composed of alternate layers of different soil types

### SAMPLE SYMBOLS

			
Shelby Tube Sample	Standard Penetration Test	Auger or Wash Sample	No Recovery

### FAILURE DESCRIPTION (COMPRESSION TEST)

B	—	Bulge	SLS	—	Failure surface occurring along slickensided plain
S	—	Shear	SAS	—	Failure surface occurring along or in sand seam
M/S	—	Multiple Shear	SS	—	Failure surface occurring in or along other secondary structure such as calcareous pockets

**TABLE 1**  
**Summary of Swell & Suction Tests**

**Keller Branch Bank**  
**Keller, Texas**  
**KETA No.: 10-113**

Boring No.	Depth -ft-	Moisture Content		Liquid Limit -%-	Plasticity Index -%-	Suction PF -%-	Swell -%-	Confined Swell Tests		
		Initial -%-	Final*					Pressure -psi-	Swell -%-	Pressure -psi-
B-1	1 – 2	17.4	18.6	44	26	3.64	1.1	2	1.5	1
	3 – 4	22.6	23.3	51	31	3.58	0.1	3	0.8	2
	5 – 6	21.0	21.8	45	27	3.66	0.3	5	0.8	2
	7 – 8	21.6	22.3	48	27	3.63	0.0	7	0.7	2
	9 – 10	17.1	18.1	49	31	3.70	0.2	8	1.2	2
	11-12	21.2	24.3	77	44	4.02	2.0	10	5.1	2
	14-15	16.4	18.6	53	31	4.16	1.1	12	3.1	2
B-2	9 – 10	22.1	24.0	53	30	4.06	1.1	8	3.0	2
	11-12	27.7	30.8	75	44	4.01	1.3	10	4.5	2
	14-15	23.2	26.2	55	35	4.07	1.8	12	4.8	2

\* Under Confining Pressure of 2 psi.



FM. HWY. 1709 -- KELLER  
PARKWAY

**CAPITAL ONE**  
KELLER  
FOUNDATION DISTRESS  
REMEDATION

S MAIN STREET AT KELLER PKWY  
KELLER, TX



Capital One  
Design/Construction Southern Franchise  
201 St. Charles Ave, Suite 2200  
New Orleans, LA 70170



**LEVINSON · ALCOSER**  
A S S O C I A T E S, L L P  
1110 TEXAS REGISTERED ENGINEERING FIRM #1-10394  
1110 TEXAS REGISTERED ARCHITECTURE FIRM #1-10394  
1110 TEXAS REGISTERED LANDSCAPE ARCHITECTURE FIRM #1-10394  
1110 TEXAS REGISTERED PLANNING FIRM #1-10394  
1110 TEXAS REGISTERED INTERIOR DESIGN FIRM #1-10394  
Architecture • Planning • Engineering/Interior  
Interior Design • Landscape Architecture  
REVISIONS



9-15-10  
29190-002

LANDSCAPING &  
IRRIGATION PLAN

**C-6**

Issued For Permit: 9/15/2010  
Issued For Pricing: 9/15/2010  
Issued For Construction:

**IRRIGATION NOTES**

1. WHEN LINES OF IRRIGATION ARE BEING REMOVED FROM EXISTING IRRIGATION LINES AND COMPENSATE DOWNSTREAM OF ZONE VALVES SHALL BE REMOVED. LINES SHALL BE CAPPED AT LIMITS OF LANDSCAPE REMEDIATION.
2. EXISTING IRRIGATION MAIN SUPPLY LINE SHALL BE LOCATED AND MARKED WITH SURVEY POINTS TO BE USED TO RELOCATE AND RECONSTRUCT. SURVEY TO EXISTING IRRIGATION TO BE MAIN SHALL NOT BE INTERRUPTED.
3. CONNECTION FITTINGS TO MAIN SUPPLY LINE SHALL BE PLACED IN A LOCATION THAT DOES NOT INTERFERE WITH EXISTING IRRIGATION SYSTEMS AND SHALL BE APPROVED PRIOR TO INSTALLATION BY LANDSCAPE ARCHITECT OF RECORD.
4. PRIOR TO IRRIGATION RECONSTRUCTION, ZONE VALVE SHALL BE RELOCATED ON MAIN SUPPLY LINE AND PLACED IN A 14" PULL/PAKE BOX. IRRIGATION SHALL BE INSTALLED THROUGH PULL/PAKE BOXES TO EXISTING MAIN SUPPLY LINE, TO BE SHOWN ON PLAN. SEE SHEET C-8 FOR DETAILS.
5. NEW ZONE VALVES SHALL BE WELDED BACK TO EXISTING IRRIGATION CONTROLLER VIA EXISTING OR NEW STEELS. CONTRACTOR SHALL COORDINATE CONNECTION POINTS PRIOR TO LANDSCAPE RECONSTRUCTION.

**LANDSCAPE NOTES**

1. PLANTER POTS MAY BE ORDERED FROM OLD TOWN FIBERGLASS, ATTN: NICK LUSKINSON, PHONE 714.633.3732, 495 SOUTH MONTGOMERY WAY, GARDEN, CA 92305-4610
2. PLANTER POTS SHALL BE INSTALLED TO BE LOCATED AS SHOWN ON SHEET C-8 FOR DETAILS.
3. STEERS SHALL BE INSTALLED BELOW PROPOSED PAVEDSIDE.

**LEGEND**

- PROPERTY LINE
- IRRIGATION SYSTEMS, 2" - 2" SCHEDULE 40 PVC TO DARKLINE IN PROPOSED PULL/PAKE BOXES
- IRRIGATION LATERAL LINE, 1/4" CLASS 200 PVC TO SHIP UP IN PROPOSED PULL/PAKE BOXES
- LIMITS OF LANDSCAPE REMEDIATION
- CROWN RISER 1818 HEAVY DUTY FLOUNDER CONCRETE
- 12" SANDWICH 14-20 BOX
- 10" ROUND H-20 BOX
- OLD TOWN FIBERGLASS PLANTER POT, GREEN/UM MODEL NO. ORCA4, COLOR TO BE SET.
- OLD TOWN FIBERGLASS PLANTER POT, GREEN/UM MODEL NO. ORCA4, COLOR TO BE SET.
- PLANT QUANTITY
- PLANT LABEL

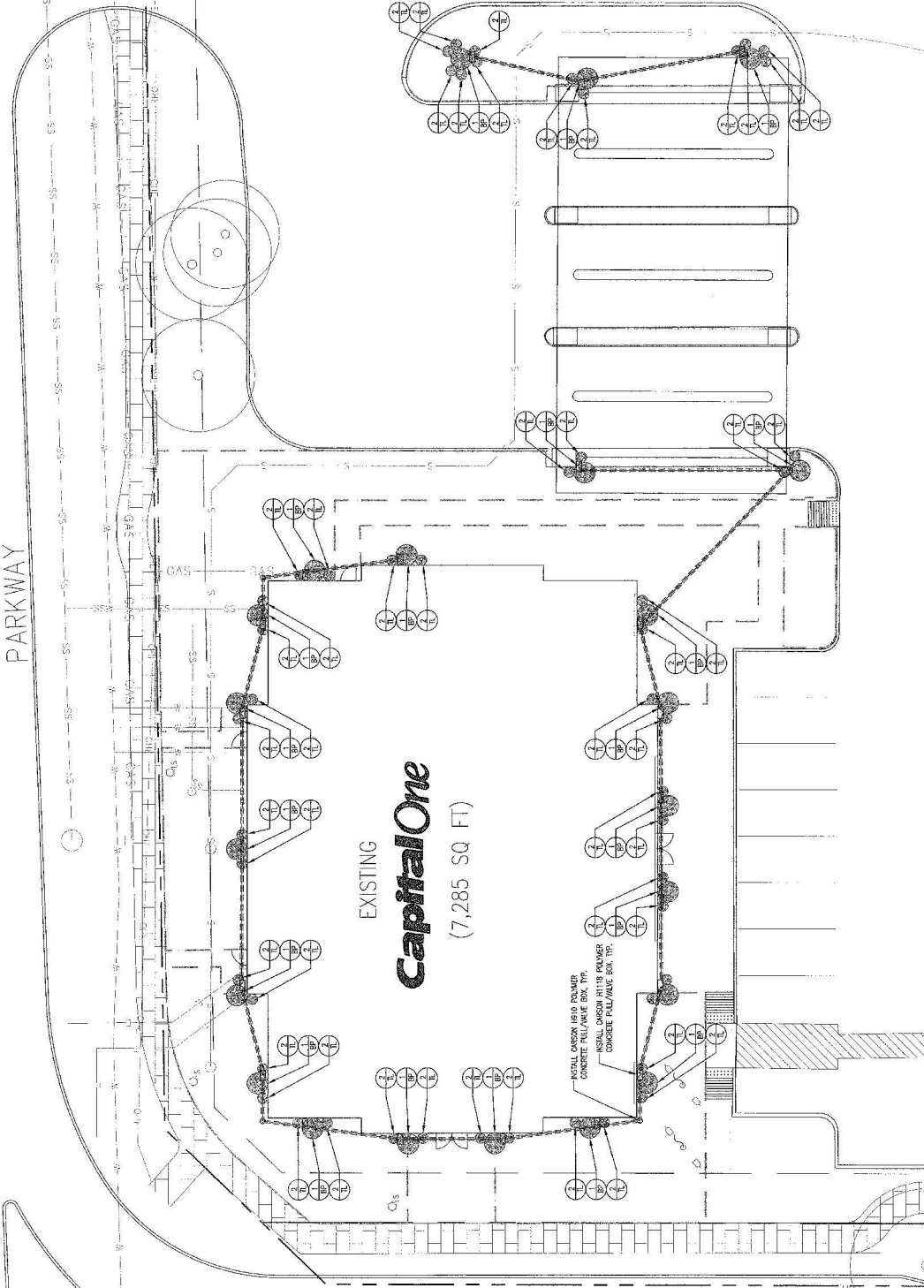

**PLANT SCHEDULE**

SURFUS / PERENNIALS	BOTANICAL NAME SIZE & CHARACTERISTICS
SP 22	BLUE FLAMBAG 7" DIA. 18" H. 1/4" SPOKE 18" 24" HEIGHT PLANTING SCHEDULE PLANTING SCHEDULE PLANTING SCHEDULE
TL 36	TRAVEL LAMBER 18" DIA. 18" H. 1/4" SPOKE 18" 24" HEIGHT PLANTING SCHEDULE PLANTING SCHEDULE PLANTING SCHEDULE

0 10 20 30  
SCALE: 1" = 10'

# CAPITAL ONE KELLER FOUNDATION DISTRESS REMEDICATION

S MAIN STREET AT KELLER PKWY  
KELLER, TX

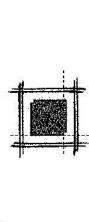

**LEVINSON • ALCOSEC**  
 A S S O C I A T E S, L. P.  
 11105 TEXAS REGISTERED ENGINEERING FIRM F-14299  
 11105 TEXAS REGISTERED ARCHITECTURE FIRM A-14299  
 11105 TEXAS REGISTERED PROFESSIONAL LANDSCAPE ARCHITECTURE FIRM L-14299  
 201 S. Charles Ave., Suite 900  
 Metairie, LA 70002  
 Tel: 713.877.0200  
 Fax: 713.877.0250  
 Architecture • Planning • Engineering  
 Interior Design • Landscape Architecture  
 REVISIONS (REV. BY):



LAALP Project Number: 29190.002  
 1/16/10

**DETAILS**  
**C-7**

Issued For Permit: 9/15/2010  
 Issued For Pricing: 9/15/2010  
 Issued For Construction:

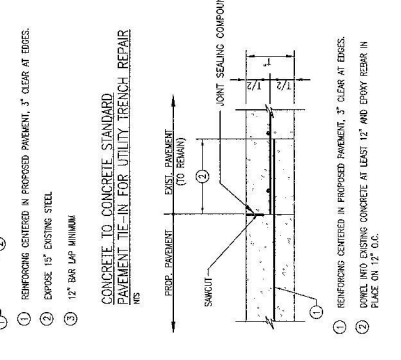
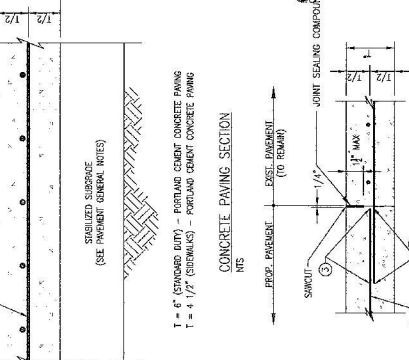
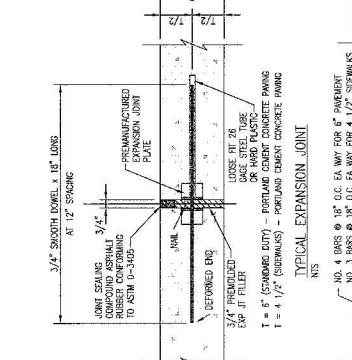
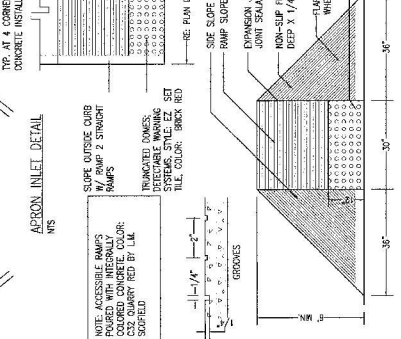
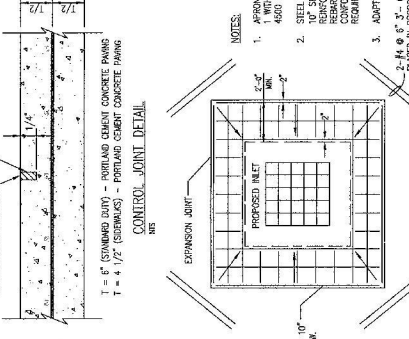
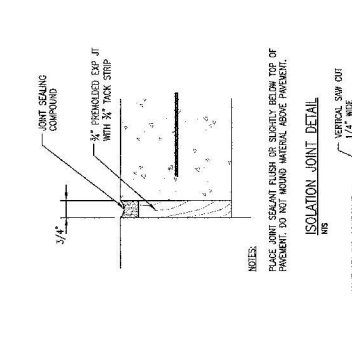
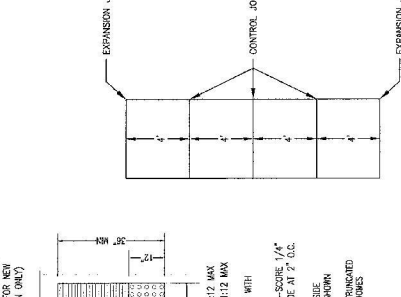
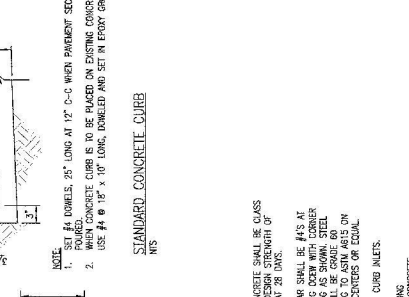
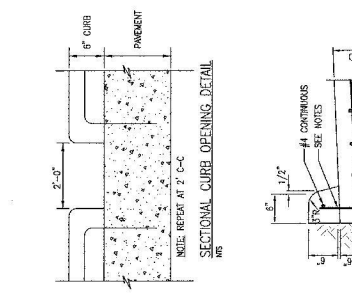
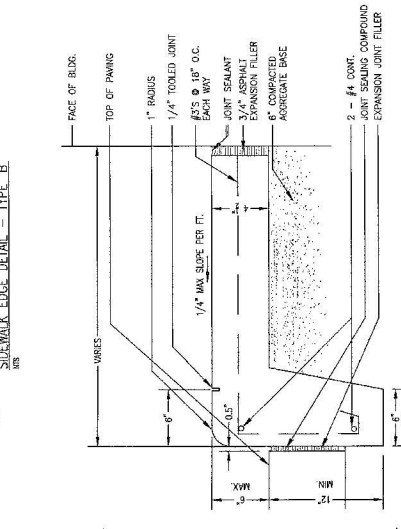
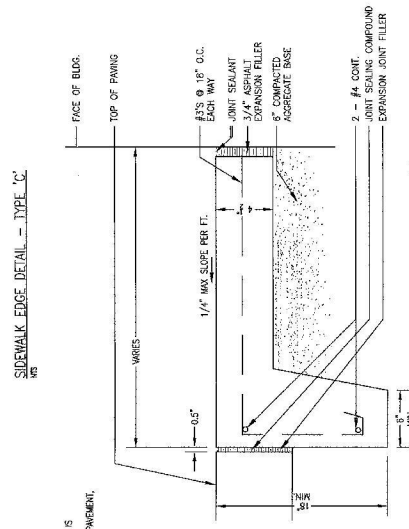
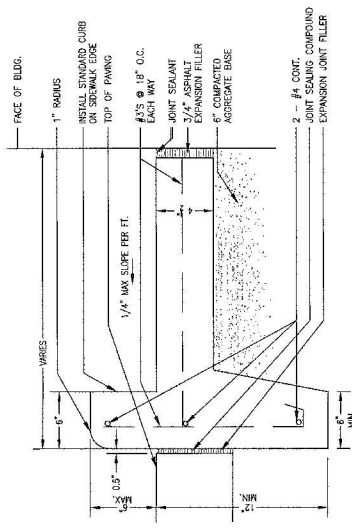

**CAPITAL ONE**  
**KELLER**  
**FOUNDATION DISTRESS**  
**REMIEDIATION**  
 S MAIN STREET AT KELLER PKWY  
 KELLER, TX



Capital One  
 Design/Construction Southern Franchise  
 201 St. Charles Ave. Suite 2200  
 New Orleans, LA 70170



**LEVINSON · ALCOBER**  
 ARCHITECTS  
 A S S O C I A T E S, L. P.  
 11015 TEXAS REGISTERED ENGINEERING FIRM F-10264  
 11110 N. SHIRLEY BOULEVARD SUITE 300  
 DALLAS, TEXAS 75243  
 TEL: 713.850.6250 FAX: 713.850.6250  
 Architecture • Planning • Engineering  
 Interior Design • Landscape Architecture

REVISIONS

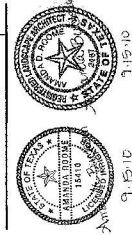



LALP Project Number: 28190.002  
 9/15/10 7/19/10

**LANDSCAPE AND**  
**IRRIGATION DETAILS**

**C-8**

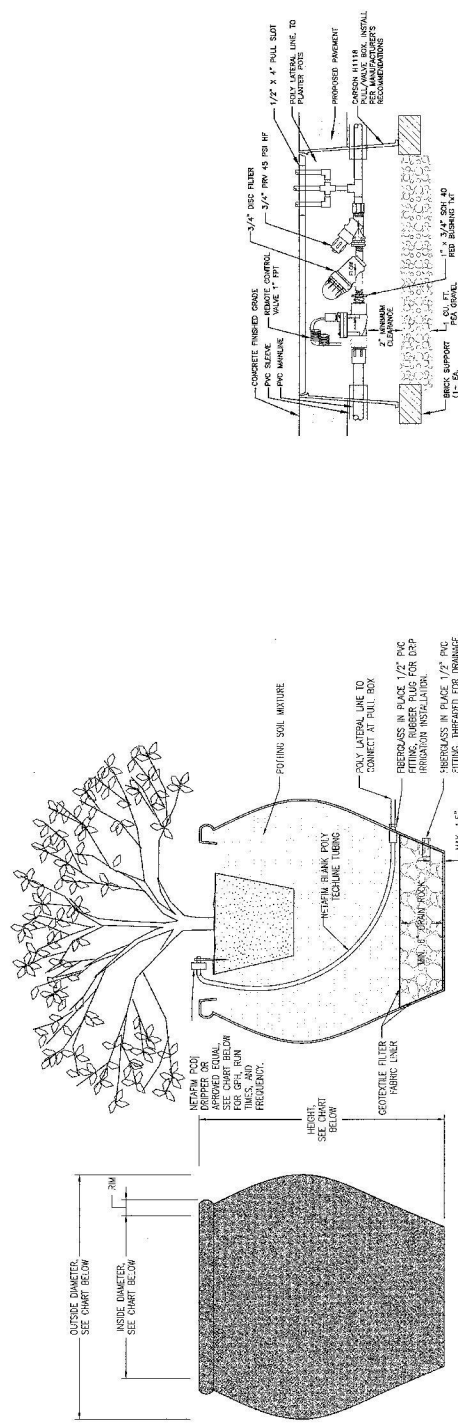
Issued For Permit: 9/15/2010  
 Issued For Pricing: 9/15/2010  
 Issued For Construction:



LOW VOLUME CONTROL ZONE ASSEMBLY P/N LVZ710073-1E  
 N/A

PLANTERS MAY BE ORDERED FROM:  
 410 TOWN FIBERGLASS  
 458 SOUTH MONTECRODY WAY  
 GARDEN, CA 92585-4075

NETWEM POCI DRIPPERS

PLANTER MODEL	RPH	RUN TIME	FREQUENCY
CP2424	0.5	4 MIN.	DAILY
CP4242	1.0	8 MIN.	DAILY

OLD TOWN FIBERGLASS MODEL GRECOIAN URN

MODEL NO.	OUTSIDE DIAMETER	INSIDE DIAMETER	HEIGHT	RPH	WEIGHT (LBS)
CP2424	24"	16"	24"	3"	26
CP4242	42"	30"	42"	3"	64

PLANTER POT AND DRIP IRRIGATION DETAIL  
 N/A



# Capital One Bank

Southeast Corner of South Main St. & Keller Parkway  
Keller, Texas



## Foundation Distress Remediation

November 16, 2010

**LEVINSON • ALCOSER**  
ASSOCIATES, L.P.

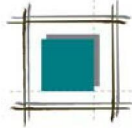

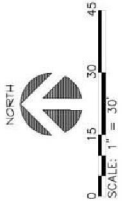

**PROPOSED LEGEND**

OLD TOWN FIBERGLASS 42" & 24" CRECIAN JURNS,  
PLANTED WITH SAGO PALMS, BLUE POINT JUNIPER,  
LANTANA AND SEASONAL COLOR  
EUROPEAN FAN STAMPED, STAIN CONCRETE.  
SIM STAIN COLOR: MAHOGANY

SCORED AND STAINED CONCRETE SIDEWALK.  
SIM STAIN COLOR: PERSIMMON

4 - LIVE OAK, *Quercus virginiana*, 2" CAL.

3 - TEXAS RED OAK, *Quercus texana*, 2" CAL.

5 - EASTERN REDBUD, *Cercis canadensis*, 1.25" CAL.

11 - YAUPON HOLLY, *Ilex vomitoria*, 1.25" CAL.

TOTAL CANOPY TREES = 7  
TOTAL ORNAMENTAL TREES = 16  
TOTAL CALIPER INCHES = 34

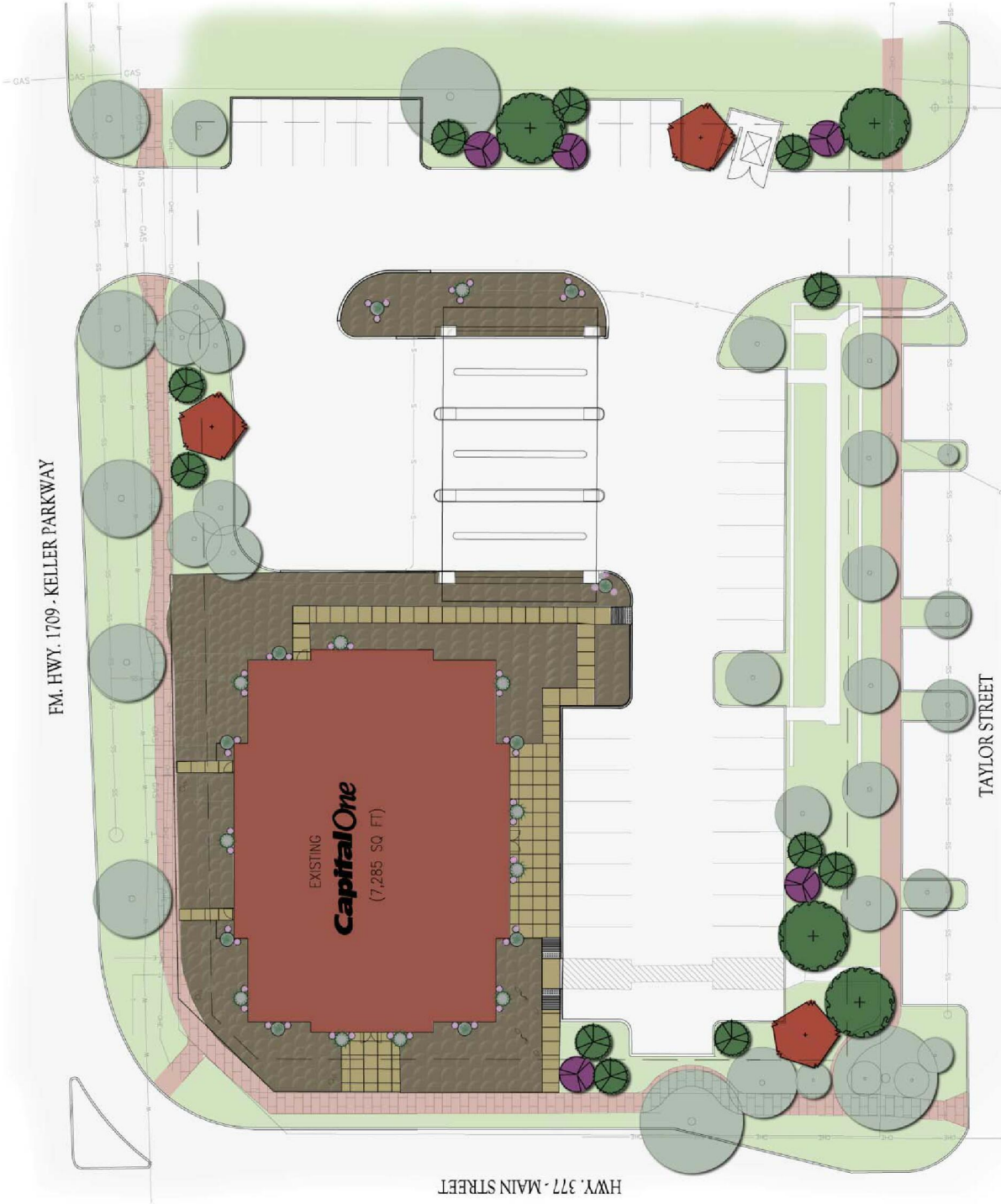
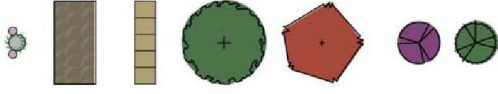

**VARIANCE EXHIBIT**  
CAPITAL ONE BANK  
KELLER, TEXAS  
NOVEMBER 16, 2010

**LEVINSON • ALCOSER**  
ASSOCIATES, L.P.

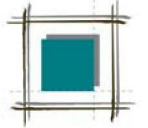

**ACCENT PAVING STAMP**

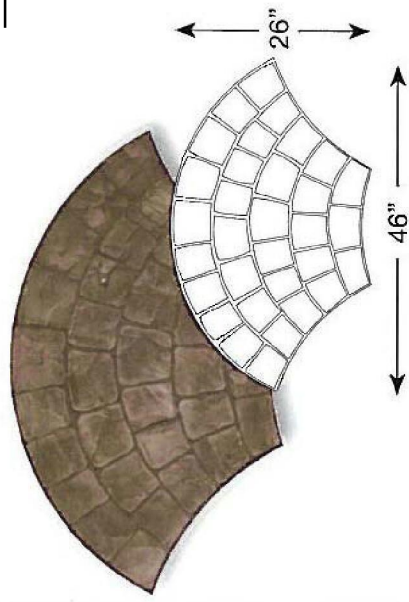

**EUROPEAN FAN**



**PROPOSED**  
**COLORS & MATERIALS**

**SIDEWALKS**



**PERSIMMON**

**ACCENT PAVING**



**MAHOAGANY**

**RAMPS**



**RUST**



**TRUNCATED DOMES:**  
**COLONIAL RED**

**GRECIAN URN**

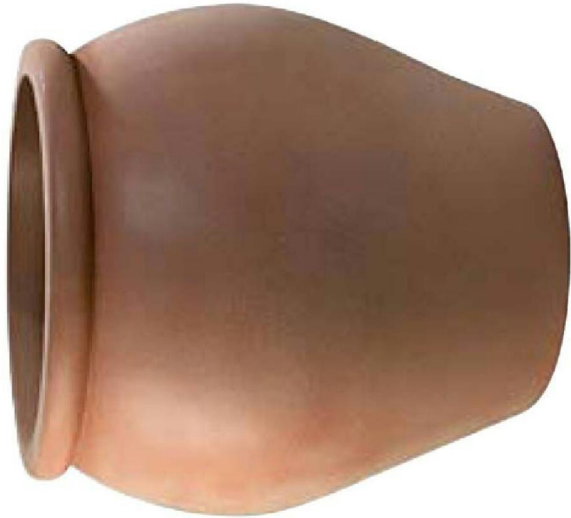

**24" POT**

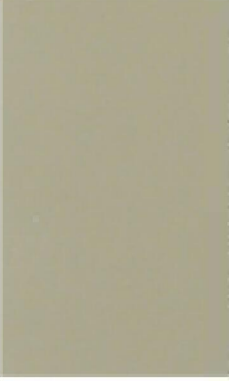

**Taupe 19-(add suffix G, M, S or O)**

**42" POT**

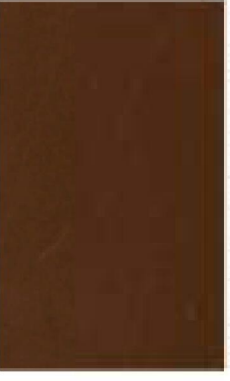

**Dark Wine 14-(add suffix G, M, S or O)**

**CANOPY TREES**



**LIVE OAK**



**TEXAS RED OAK**

**PROPOSED**  
**PLANT PALLET**



**EASTERN REDBUD**

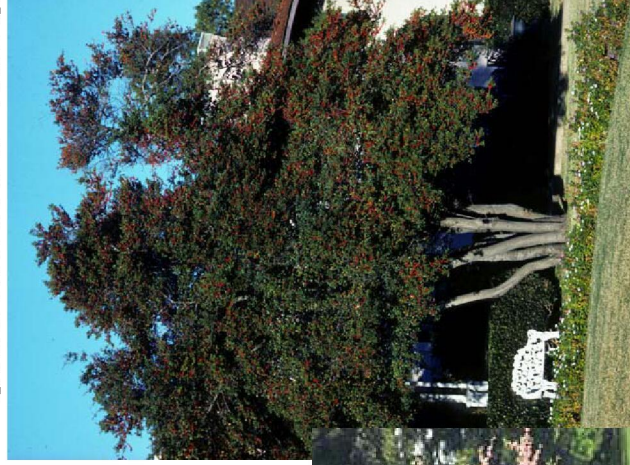

**YAUPON HOLLY**

**ORNAMENTAL TREES**



**BLUE POINT JUNIPER**

**POTTED PLANTS**



**SAGO PALM**

**POTTED ACCENT**



**TRAILING LANTANA**



**PERSPECTIVE RENDERING**  
**CAPITAL ONE BANK**  
**KELLER, TEXAS**  
**NOVEMBER 16, 2010**





**NEIGHBORING BUILDING**  
SOUTHWEST CORNER OF SOUTH MAIN STREET AND KELLER PARKWAY



**NEIGHBORING BUILDING**  
SOUTHWEST CORNER OF SOUTH MAIN STREET AND KELLER PARKWAY



**NEIGHBORING BUILDING**  
NORTHWEST CORNER OF SOUTH MAIN STREET AND KELLER PARKWAY





**NEIGHBORING BUILDING**  
NORTHWEST CORNER OF SOUTH MAIN STREET AND KELLER PARKWAY