

# The Keller Sports Park Playground Replacements



# Keller Sports Park Baseball

TimberForm &  
PipeLine

Installed in 1998



# Keller Sports Park Baseball

Which playground would you like to see be installed by the Pavilion?

741 responses

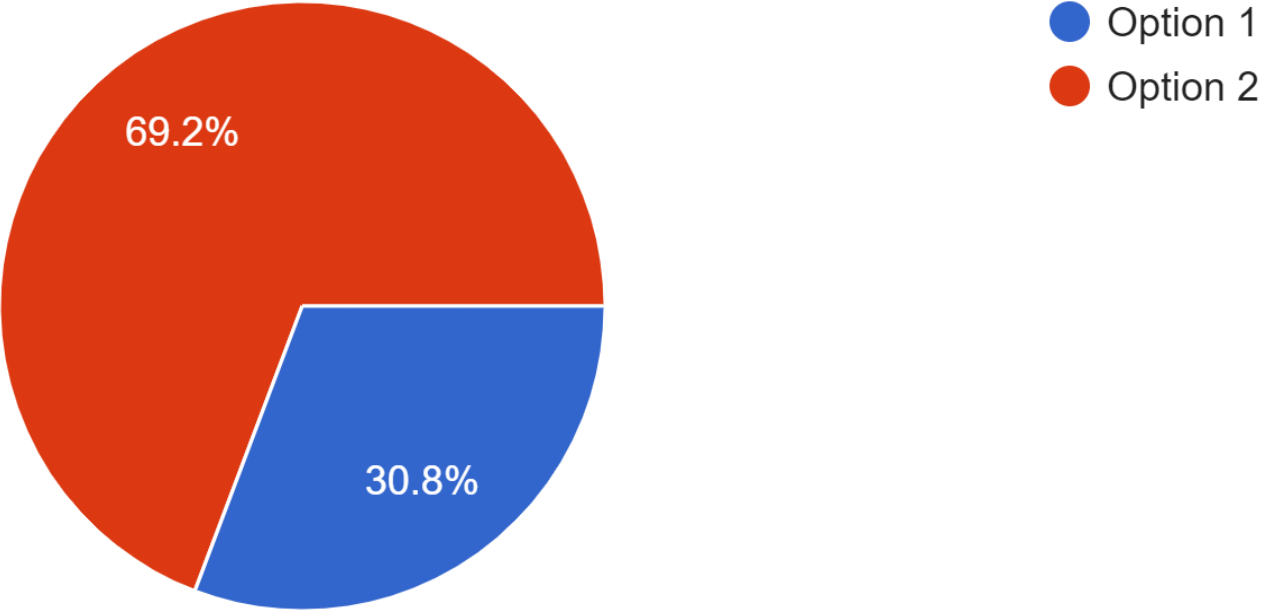

# Keller Sports Park Baseball

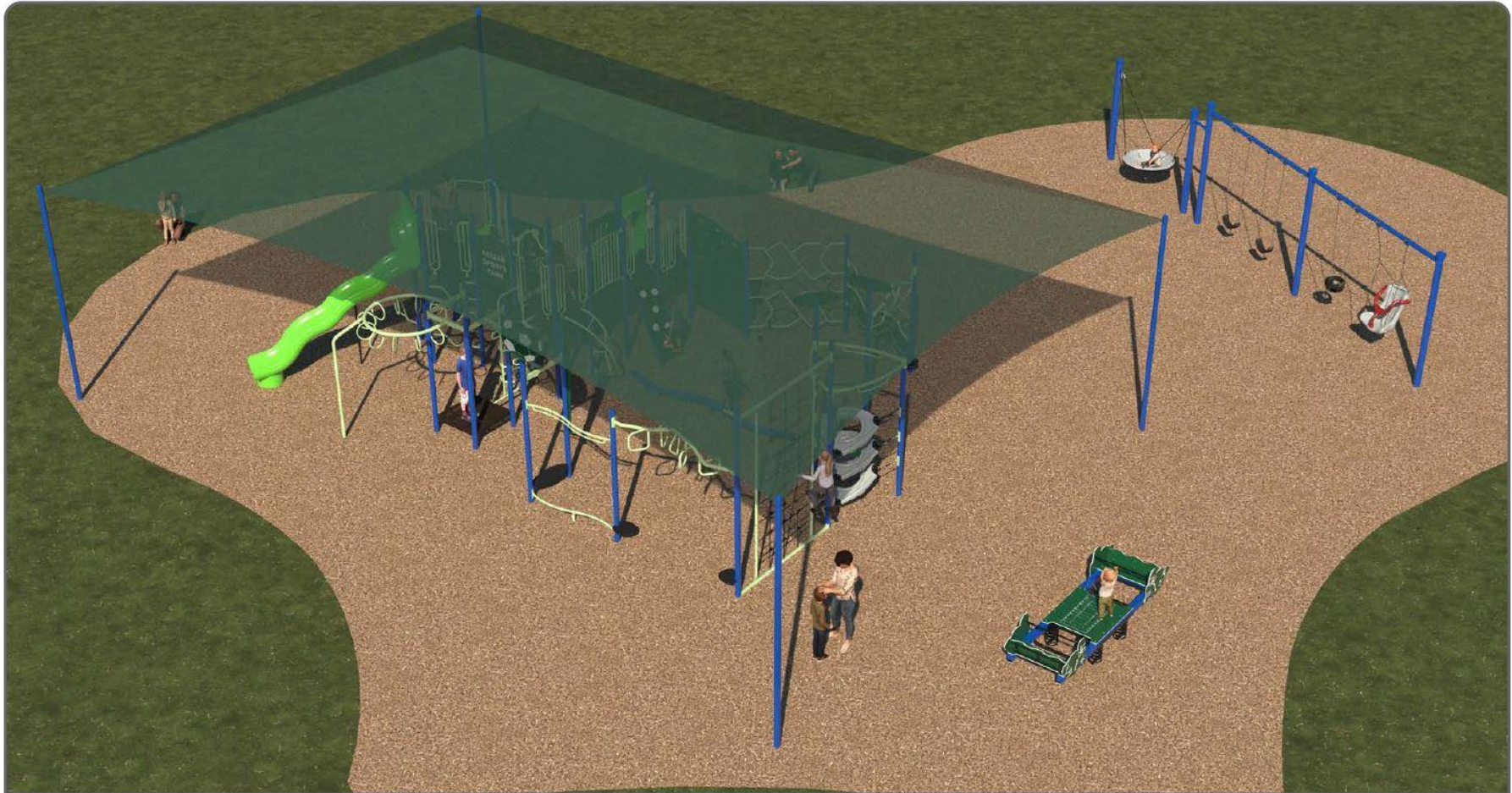

**Henderson**<sup>®</sup>  
Providing Playground Fun

Model No. B311769RO



**Colors:**

- Posts: Blue
- Accents: Green Pastel
- Roto-Plastic: Green - Lime
- HDPE-Plastic: Green / White

**KELLER SPORTS PARK  
5-12 AREA - OPTION 2**



*For illustration purposes only. COLORS TBD. Copyright Protected. Not to be shared without written permission.*



# Keller Sports Park Baseball



**Henderson**  
Providing Playground Fun

Model No. B311769RO



**Colors:**

- Posts: Blue
- Accents: Green Pastel
- Roto-Plastic: Green - Lime
- HDPE-Plastic: Green / White

**KELLER SPORTS PARK  
5-12 AREA - OPTION 2**



*For illustration purposes only. COLORS TBD. Copyright Protected. Not to be shared without written permission.*



# Keller Sports Park Baseball



**Henderson**<sup>®</sup>  
Providing Playground Fun

Model No. B311769R0



**Colors:**

Posts: Blue  
Accents: Green Pastel  
Roto-Plastic: Green - Lime  
HDPE-Plastic: Green / White

**KELLER SPORTS PARK**  
5-12 AREA - OPTION 2



*For illustration purposes only. COLORS TBD. Copyright Protected. Not to be shared without written permission.*



# Keller Sports Park Baseball



**Henderson®**  
Providing Playground Fun

Model No. B311769RO



*For illustration purposes only. COLORS TBD. Copyright Protected. Not to be shared without written permission.*

**Colors:**

Posts: Blue  
Accents: Green Pastel  
Roto-Plastic: Green - Lime  
HDPE-Plastic: Green / White

**KELLER SPORTS PARK  
5-12 AREA - OPTION 2**



# Keller Sports Park Baseball

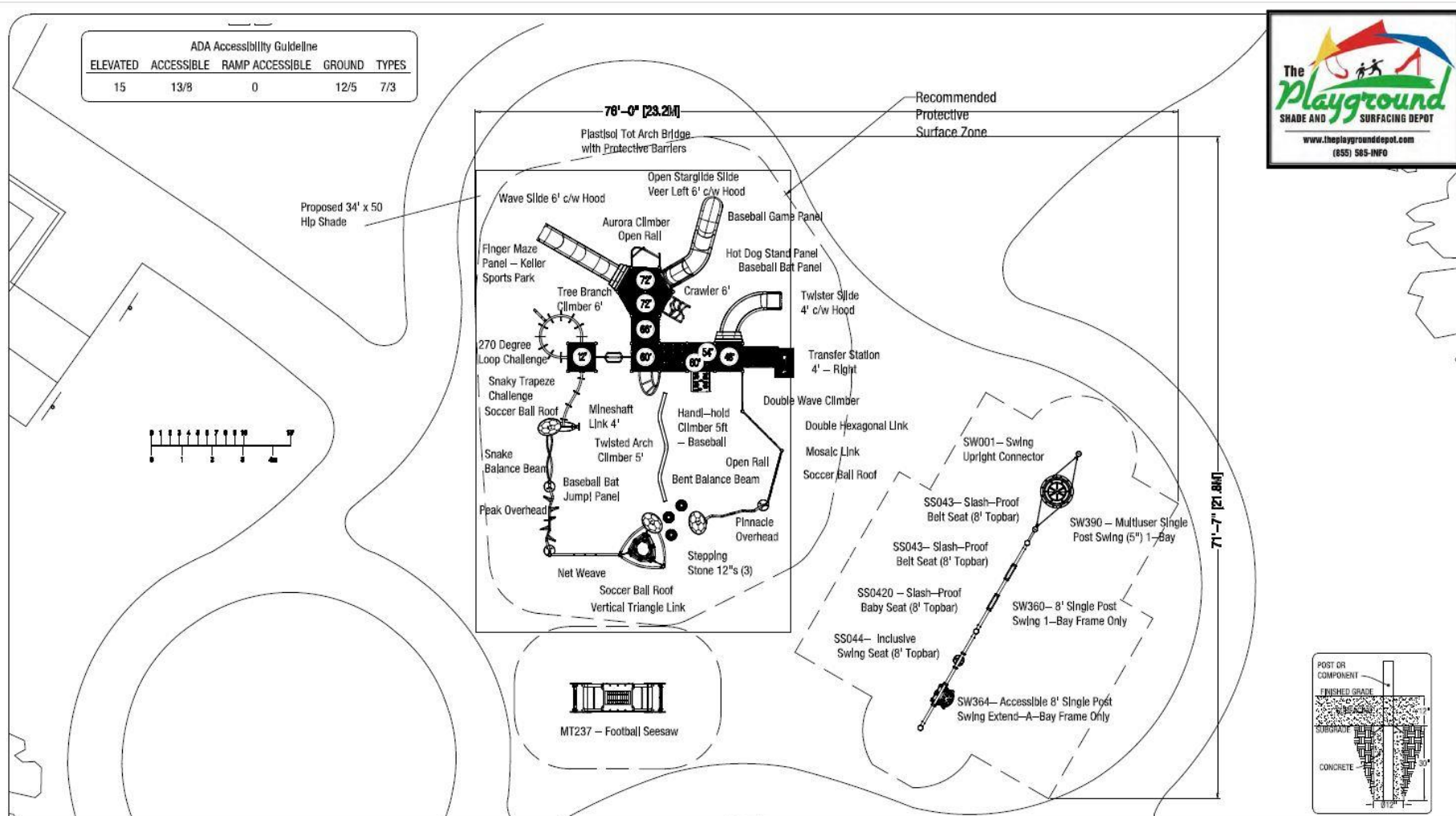

ADA Accessibility Guideline				
ELEVATED	ACCESSIBLE	RAMP ACCESSIBLE	GROUND	TYPES
15	13/8	0	12/5	7/3

**Model No. B311769R0**

The Playground Shade & Surfacing Depot  
Keller Sports Park – 5–12 Area – Option 2

*For illustration purposes only. COLORS TBD. Copyright Protected. Not to be shared without written permission.*

Salesperson | A.C.  
Drawn By | R.H.  
Date Drawn | May 16, 2024  
Revised By |  
Revision Date |

Product Line | Playsteel FIT  
Standard Compliance | ASTM F 1487, CPSC  
Best User Age | 5 to 12 yrs  
Protective Surfacing Type | Wood Chips  
Accessibility | ADA  
Number of Children | 111

Maximum Fall Height | 10'

Border Area | 4,843 sq/ft  
Border Perimeter | 286'  
Installation Type | Inground

WARNING: All play equipment shall have a protective surfacing zone that consists of an outside free soft resilient surfacing, as specified for each type of equipment and at depths to meet the critical fall heights as specified by the CAN/CSA Z95.4, ASTM F1487 and the U.S. Consumer Product Safety Committee.

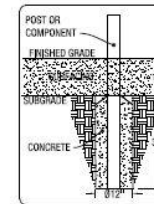



# Keller Sports Park Baseball

## Keller Sports Park Opt. 2

Hip Shade					
Length	50'	Width	34'	Entry Height	14'
Peak Height	20.86'	Elbow	Standard	Column Mount	Base Plate
Column Size	12"x12"x14"	Rafter Size	7"x5"x3/16"	Ridge Size	7"x5"x3/16"
Column Length	14.5'	Rafter Length	24.17'	Ridge Length	18.5'
Dome Qty.	1	Column Qty.	4		

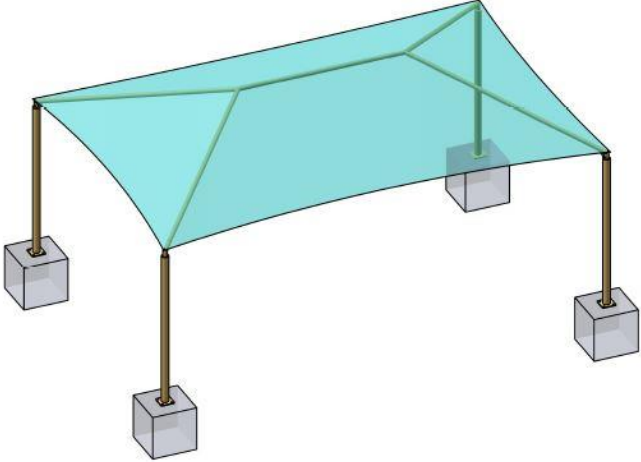
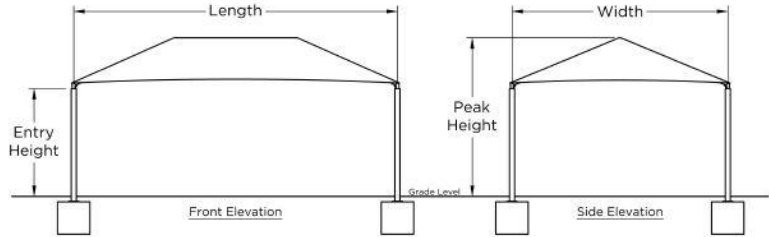

  

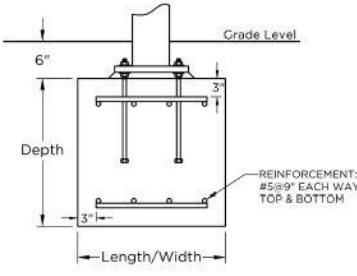

Square Footing		
Column	Length & Width	Depth
Single Cap	6.24	3
Double Cap	N/A	3

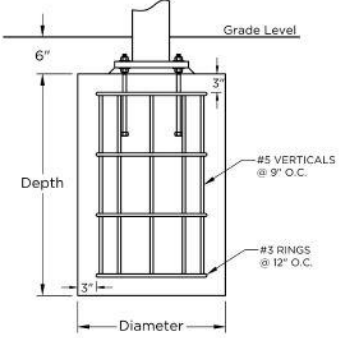

  

Auger Footing		
Diameter	Single Cap Depth	Double Cap Depth
1'-6"		
2'-0"	Out of range	N/A
2'-6"	Out of range	N/A
3'-0"	13.22	N/A

  

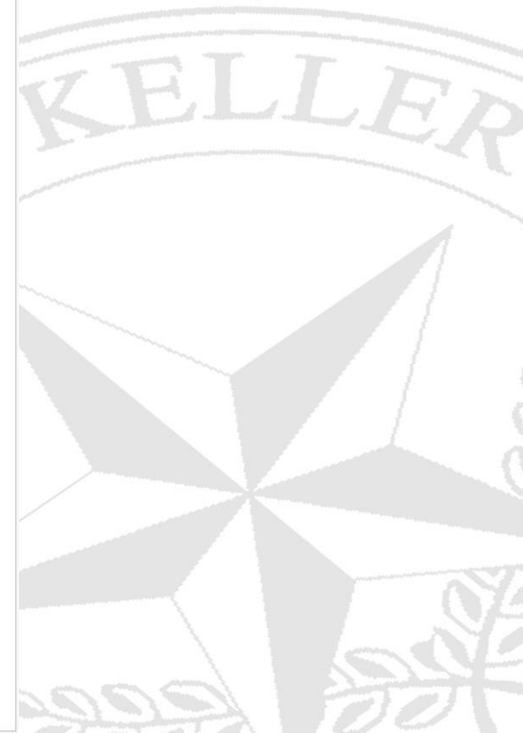

	QUOTE	SHADE SIZE	SHADE STYLE	These drawings are for reference only and should not be used as construction details. They show the general character and rough dimensions of the structural features. Exact spans, fasteners, materials, and foundations can be determined by a licensed professional engineer upon request. Estimated footing size above is based on 1,500 PSF soil bearing pressure.
		50 X 34	Hip Shade	

For illustration purposes only. COLORS TBD. Copyright Protected. Not to be shared without written permission.

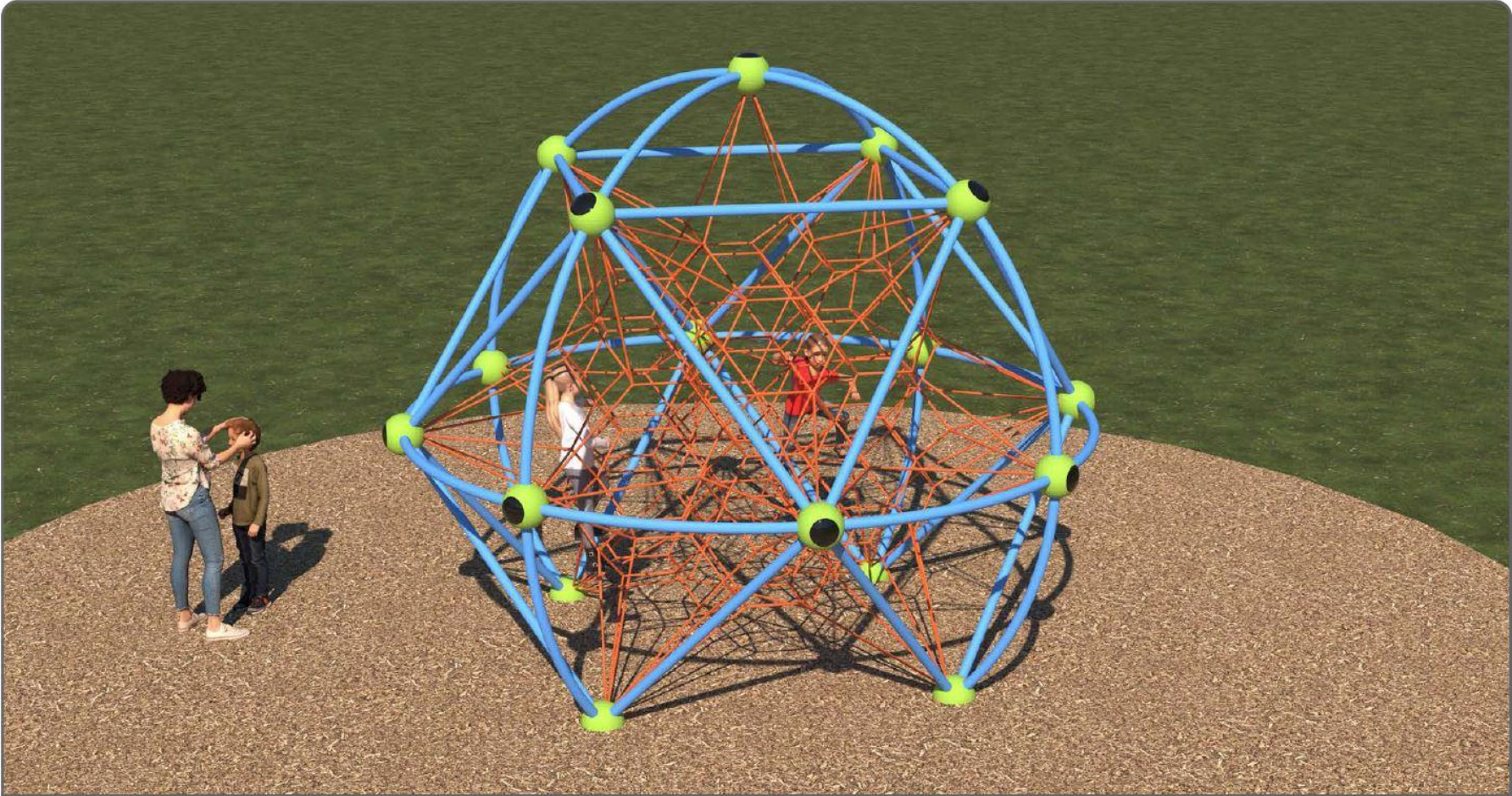

# Keller Sports Park Baseball



**Henderson**  
Providing Playground Fun

Model No. LO6142R0



For illustration purposes only. COLORS TBD. Copyright Protected. Not to be shared without written permission.

**Colors:**

- Berliner Posts: Light Blue
- Berliner Balls: Orange
- Berliner Rope: Orange

**KELLER SPORTS PARK - 5-12  
NET CLIMBER**



# Keller Sports Park Baseball

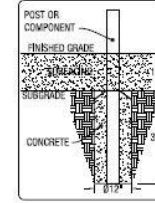
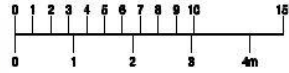
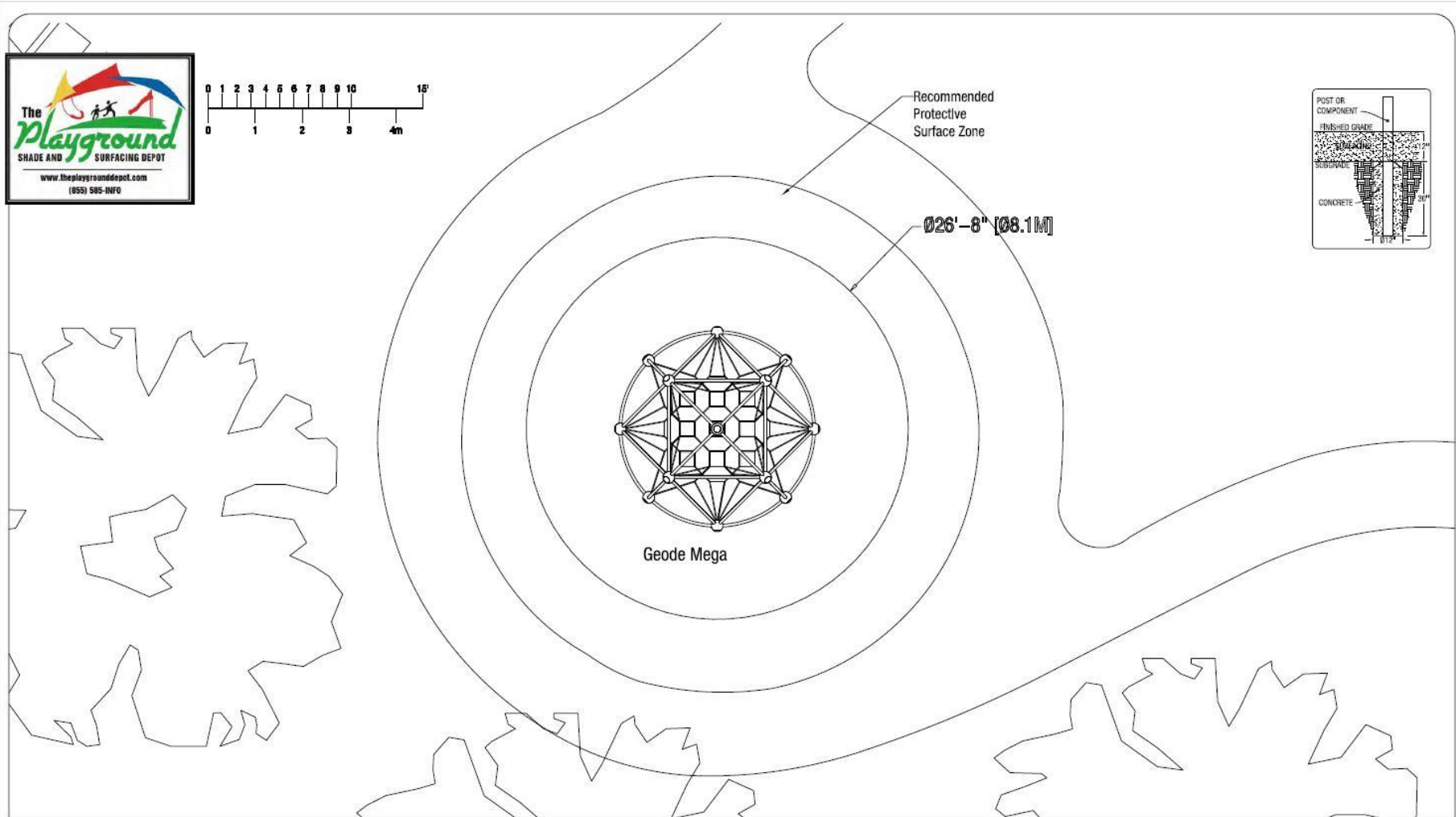

**Model No. L06142R0**

The Playground Shade & Surfacing Depot  
Keller Sports Park – Net Climber Area

*For illustration purposes only. COLORS TBD. Copyright Protected. Not to be shared without written permission.*

Salesperson | A.C.  
Drawn By | R.H.  
Date Drawn | May 16, 2024  
Revised By |  
Revision Date |

Product Line | Playsteel  
Standard Compliance | ASTM F 1487, CPSC  
Best User Age | 5 to 12 yrs  
Protective Surfacing Type | Wood Chips  
Accessibility | None  
Number of Children | 17  
Maximum Fall Height | 6'

Border Area | 1,013 sq/ft  
Border Perimeter | 113'  
Installation Type | Inground

WARNING: All play equipment shall have a protective surfacing zone that consists of an obstacle free soft resilient surfacing, as specified for each type of equipment and at depths to meet the critical fall heights as specified by the CA/CPSA 2614, ASTM F1487 and the U.S. Consumer Product Safety Commission.



# Keller Sports Park Soccer

TimberForm &  
PipeLine

Installed in 2003

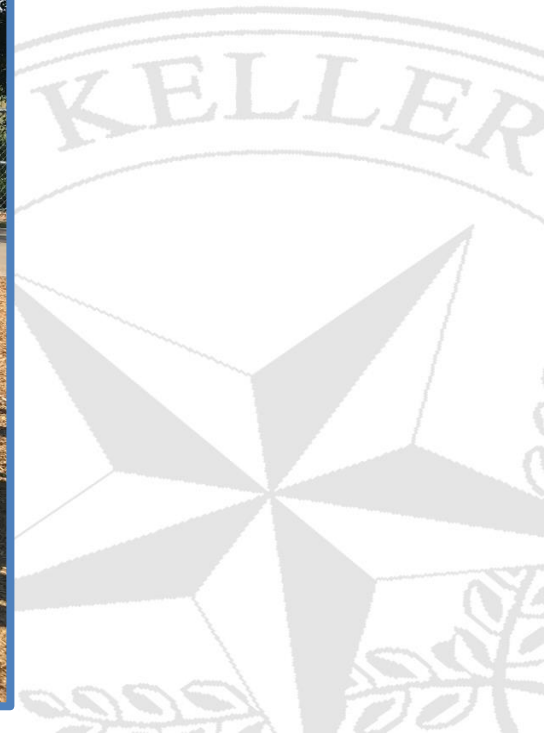

# Keller Sports Park Soccer

Which playground would you like to see be installed by the Soccer Fields?

741 responses

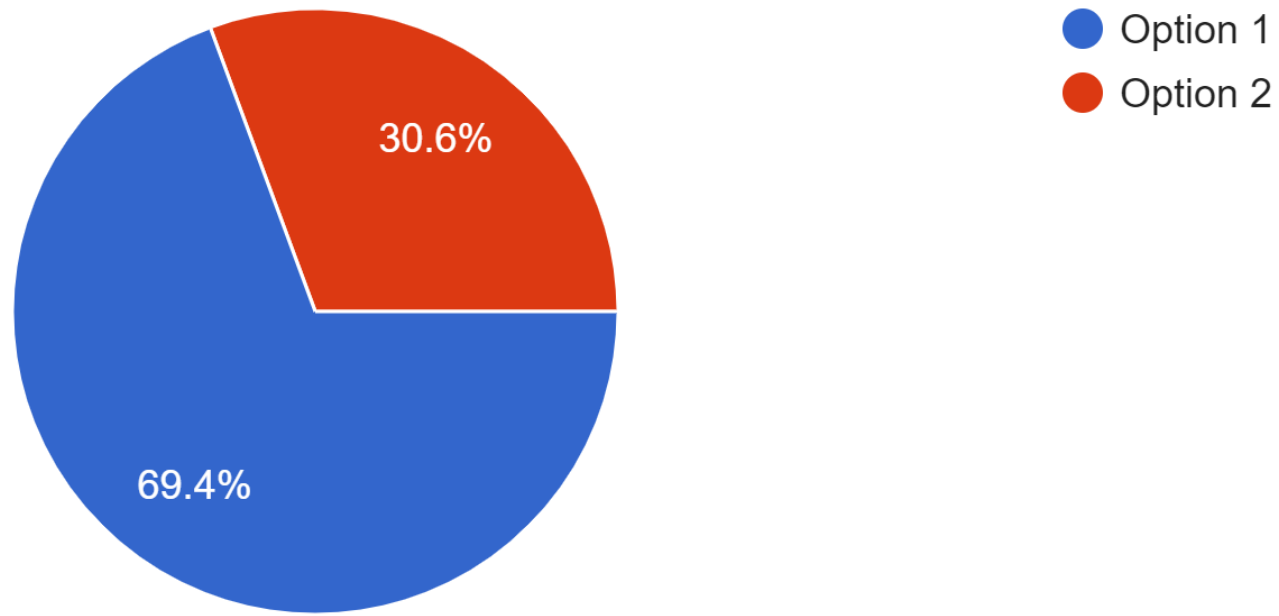

# Keller Sports Park Soccer



**Henderson®**  
Providing Playground Fun

Model No. B311767R1



#### Colors:

Posts: Light blue  
Accents: Orange - Light Blue  
Roto-Plastic: Lime  
HDPE-Plastic: White / Black  
Shade: Lime

**KELLER SPORTS PARK**  
**2-5 AREA**



*For illustration purposes only. COLORS TBD. Copyright Protected. Not to be shared without written permission.*



# Keller Sports Park Soccer



**Henderson®**  
Providing Playground Fun

Model No. B311767R1



For illustration purposes only. COLORS TBD. Copyright Protected. Not to be shared without written permission.

## Colors:

Posts: Light blue  
Accents: Orange - Light Blue  
Roto-Plastic: Lime  
HDPE-Plastic: White / Black  
Shade: Lime

KELLER SPORTS PARK  
2-5 AREA



# Keller Sports Park Soccer



**Henderson®**  
Providing Playground Fun

Model No. B311767R1



#### Colors:

Posts: Light blue  
Accents: Orange - Light Blue  
Roto-Plastic: Lime  
HDPE-Plastic: White / Black  
Shade: Lime

**KELLER SPORTS PARK**  
**2-5 AREA**



*For illustration purposes only. COLORS TBD. Copyright Protected. Not to be shared without written permission.*





# Keller Sports Park Soccer



**Henderson**<sup>®</sup>  
Providing Playground Fun

Model No. B311767R1



#### Colors:

Posts: Light blue  
Accents: Orange - Light Blue  
Roto-Plastic: Lime  
HDPE-Plastic: White / Black  
Shade: Lime

KELLER SPORTS PARK  
2-5 AREA



*For illustration purposes only. COLORS TBD. Copyright Protected. Not to be shared without written permission.*



# Keller Sports Park Soccer

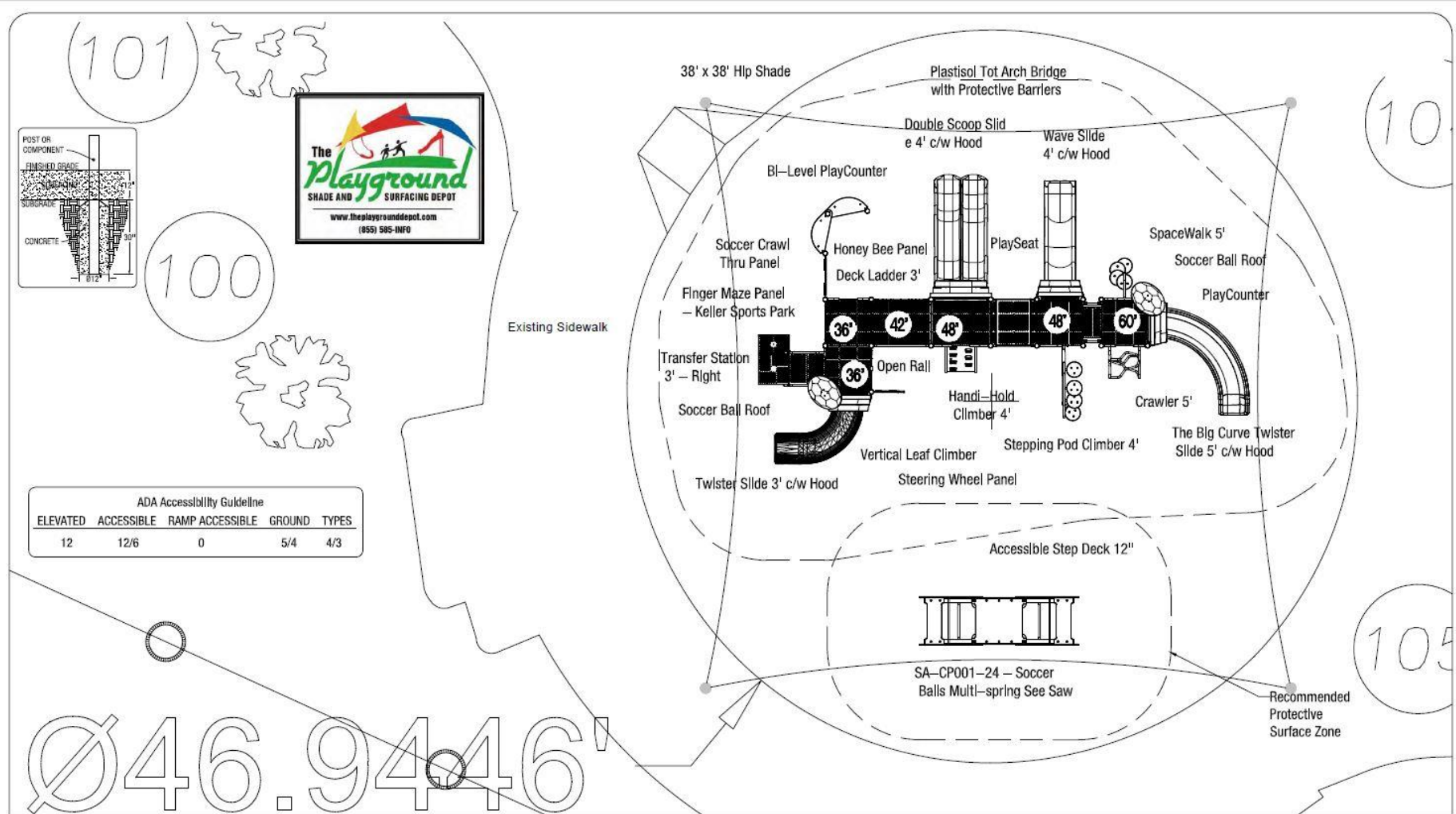

**Model No. B311767R1**

The Playground Shade & Surfacing Depot

Keller Sports Park - 2-5 Area

For illustration purposes only. COLORS TBD. Copyright Protected. Not to be shared without written permission.

Salesperson | A.C.  
 Drawn By | R.H.  
 Date Drawn | May 16, 2024  
 Revised By | R.H.  
 Revision Date | October 17, 2024

Product Line | Playsteel FIT  
 Standard Compliance | ASTM F 1487, CPSC  
 Best User Age | 2 to 5 yrs.  
 Protective Surfacing Type | Wood Chips  
 Accessibility | ADA  
 Number of Children | 68

Border Area | 1,766 sq/ft  
 Border Perimeter | 150'  
 Installation Type | Inground

WARNING: All play equipment shall have a protective surfacing zone that consists of an obstacle free soft resilient surfacing, as specified for each type of equipment and at depths to meet the critical fall heights as specified by the CAN/CSA Z95.4, ASTM F1487 and the U.S. Consumer Product Safety Committee.

Maximum Fall Height | 5'

# Keller Sports Park Soccer

## Keller Sports Park 2-5 Soccer Area Hip Shade

Hip Shade					
Length	38'	Width	38'	Entry Height	11'
Peak Height	18.04'	Elbow	Standard	Column Mount	Base Plate
Column Size	Ø8.6" Sch-40	Rafter Size	7"x5"x3/16"	Ridge Size	7"x5"x3/16"
Column Length	11.5'	Rafter Length	24.77'	Ridge Length	9.5'
Dome Qty.	1	Column Qty.	4		

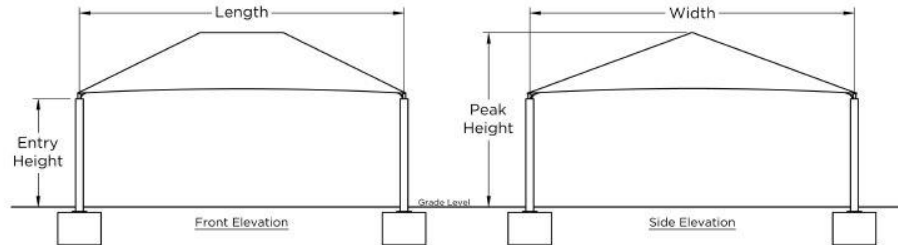
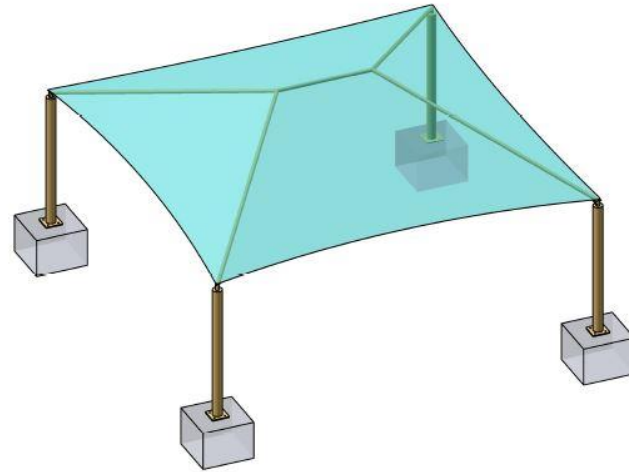

Square Footing		
Column	Length & Width	Depth
Single Cap	5.14	3
Double Cap	N/A	3

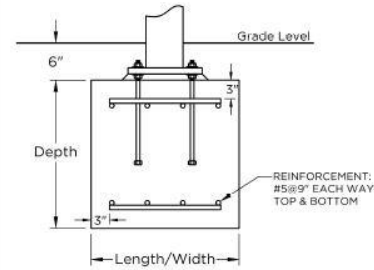

Auger Footing		
Diameter	Single Cap Depth	Double Cap Depth
1'-6"	Out of range	N/A
2'-0"	Out of range	N/A
2'-6"	Out of range	N/A
3'-0"	8.98	N/A

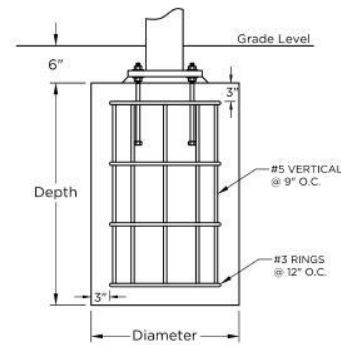

QUOTE	SHADE SIZE	SHADE STYLE
88560	38 X 38	Hip Shade

*These drawings are for reference only and should not be used as construction details. They show the general character and rough dimensions of the structural features. Exact spans, fasteners, materials, and foundations can be determined by a licensed professional engineer upon request. Estimated footing size above is based on 1,500 PSF soil bearing pressure.*

For illustration purposes only. COLORS TBD. Copyright Protected. Not to be shared without written permission.





**Questions?**

Cody Maberry 817-743-4002

